

*Juén*

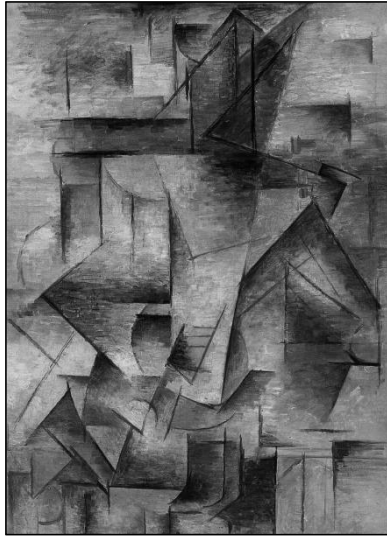

# SIRACUSA 15R/16R

— MANUAL —

MANSRV22 - August 2023





## CONTENTS



<b>CARE</b>	<b>3</b> 
<b>MAINTENANCE</b>	<b>5</b>
<b>Tools</b>	<b>5</b>
<b>Changing Strings</b>	<b>5</b>
<b>Adjusting the Bridge Height</b>	<b>6</b>
<b>Adjusting the Compensation</b>	<b>7</b>
<b>Adjusting the Truss Rod Tension</b>	<b>9</b>
<b>Adjusting the Pickup-String Clearance</b>	<b>11</b>
<b>Checking/Replacing the Battery</b>	<b>12</b>
<b>USE</b>	<b>13</b>
<b>Electric Controls</b>	<b>13</b>
<b>Deciding on the Amplifier</b>	<b>14</b>
<b>Connecting Your Guitar</b>	<b>16</b>
<b>Specifications</b>	<b>21</b>

*Juén*

## CARE



Siracusa guitars are nothing like conventional archtops with plates that triple the thickness, virtually indestructible. So, please, **read and observe what follows.**

-  **Do not allow the guitar to stay in places where humidity, temperature or light conditions are extreme.** These can affect very seriously the stability of wood and adhesives. **Relative Humidity must be kept around 50% at all times!**
- Try not to press excessively on the sides of your instrument. For example, trying to reach for something on the floor ahead of you while playing seated.
-  Oil finishes are soft, so they don't form a tough coat on top of the wood. This is really very different from the conventional guitar finishes that you already know. **If your guitar has an oil finish, treat it very carefully, especially the very soft top. Also, see page 8 for a special situation where the top can suffer damage.**
- Protect your instrument from accidents:
 

Try to keep it in its case, always with the drawbolts closed, when you are not using it. Do not trust too much in the stability of guitar stands.

Try not to wear buckles, key holders or zippers that may cause damage to the instrument while playing.



- Clean your instrument with well proven products designed specifically for this job. Avoid abrasive cleaners or those containing silicone or solvents such as alcohol or acetone.
- Do not try to lubricate the machine heads.
- Try to clean the strings after use with a dry clean cloth.
- Avoid the contact with alcoholic beverages. If it happens sometime, absorb them with a dry cloth without rubbing.
- Connect your instrument only to reliable equipment that have a ground connection. The power line must have a ground-fault interrupter. If you do not follow these recommendations, you can cause damage to the instrument as well as to yourself.
-  If you don't plan to use your guitar for some time, **remove the battery to avoid leak damage.**
- If you are going to modify your instrument, contact me first.
- If you are a repairman working on this guitar, please contact me if you have any doubts on how to perform the repairs. I can also supply the necessary parts.
- Even if you are careful with your instrument, some wear will take place in normal use:
  - Frets must be redressed or changed after some time.
  - The finish and the wood below it can suffer color changes, usually to a more yellow/orange hue. The high gloss will not last a lifetime.
  - The gold or chrome plated pieces may lose their plating.

## MAINTENANCE

### Tools

Your guitar comes with a tool pouch, enough for the most common operations described below. It contains a small (2 mm) and a large (4 mm) Hex keys.

### Changing Strings

*You should do this...*

Whenever the strings don't sound bright, are worn or dirty or have tuning problems in certain areas of the fretboard.

*Necessary tools and materials:* Pliers and strings.

*Method:*

- Loosen one string. To untie it from the machines and the tailpiece, **cut it with the pliers**. This is the best way to avoid damaging the string anchors at the tailpiece, your fingers or the finish.
- Place the new string in the tailpiece.
- Insert the string into the hole in the post and pull until it is around 50 mm high above the fretboard.
- Bend the end slightly, just at the exit from the tuner post.
- Turn the tuner until the string feels tight, then tune it.
- Cut the remaining, leaving about 1 cm out of the post.
- Repeat for each string.



## Adjusting the Bridge Height

*You should do this...*

Whenever there are buzzes in wide areas of the fretboard. The height may be lowered if the action is too high and there are no buzzes.

*Necessary tools:* You will need the small Hex key supplied with the guitar.

*Method:*

Depending on the problem affecting more the bass strings than the treble strings, you will have to turn the corresponding adjustment screw to each side of the bridge saddle. Clockwise to lower it, and counterclockwise to raise it. The adjustment will be finished when the strings are high enough so that, in your playing style, there are no buzzes.

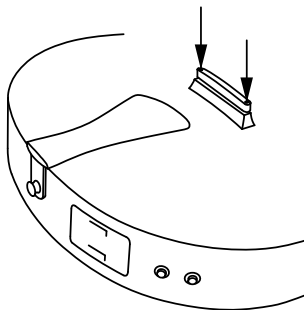

*Notes:*

- I usually set the action very low before delivering my instruments. You can always raise it if you like it better.
- If you use **thin** plain strings, it is possible to have buzzes because they don't have enough tension for straightening out the small irregularities in the steel caused by playing. Use new strings before performing any adjustment.
- After this adjustment, you should also check the truss rod tension and compensation adjustments, as explained later.



## Adjusting the Compensation

This procedure must be performed so that all the notes and their octaves sound reasonably in unison, independent from their position on the fretboard. A guitar that is not well compensated can be especially unpleasant when playing chords that mix notes fingered in high frets with open strings.

*You should do this...*

- When your new strings are a different gauge, or you plan to use an alternate tuning permanently.
- When the bridge has been moved, usually as a consequence of removing all the strings (which I don't recommend).
- When the height of the bridge has been modified substantially.

*However...*

- Don't do this every time that you change the strings, it's not necessary.
- Don't do this if you find that your worn strings don't intonate well. Instead, change them and check if the new ones are OK.

*Necessary tools:* Electronic tuner or a good ear.

*Method:*

- Start with new strings, *already tuned in the guitar for at least a few hours.*
- Check if the natural harmonic for the second string in fret 12 is the same as the fingered note in that same fret. If the tuner (or your ear) finds that the fingered note is higher than the harmonic, the

bridge will have to be moved closer to the tailpiece. Otherwise, move it further away from the tailpiece (see drawing).

- Check the same for the fifth string, but this time try to move only the bass side of the bridge, as you should not modify its position for the string that you adjusted first.

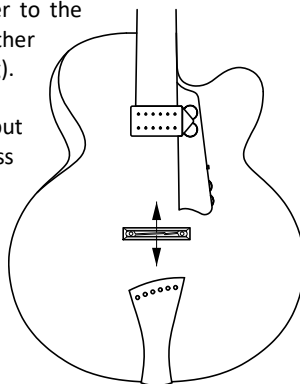

Notes:

-  Some bridges may be hard to move. Don't force anything, you can damage the top if you press hard on it. It is better to loosen the strings but, **if the finish is oil, then loosen the strings completely!**
- Worn strings, deformed from playing or dirty can be impossible to play in tune—never try to adjust the compensation for old strings, it's wasted time.
- Some wound strings have defects in the uniformity of their windings that make them useless. Plain strings have their problems too: some show a kind of coiling right out of the package that doesn't correspond to the curvature that they assumed while in the package—don't use these, especially if they are in a low tension set.
- The fixed bridges found in archtop guitars don't allow a perfect adjustment for every string, but the discrepancy is usually quite small.
- The saddle in your guitar has been adjusted for string sets that have a wound third string. If you use a plain third, you may need a different saddle. Inquire.

## Adjusting the Truss Rod Tension

*You should do this...*

When there are buzzes but the action is high. This has three main probable causes:

- Change of the tension exerted on the neck, usually following the change of the string gauge or alternate tunings.
- Wood adaptation to the strings/truss rod tension and compression forces. This is especially important during the first year of life of the instrument.
- Changes in relative humidity.

*Necessary tools:* There are two different methods, depending on your playing style. To perform the “A” method you will need a thin guitar string (0.010”) and, perhaps, some assistance. For the “B” method, you won’t need the string. If, after the check, you must make the adjustment, you will need both the small and the large Hex keys supplied with the guitar.

*Method A.- This is the way to adjust your guitar if your style is more limited to the first frets, including lots of open strings.*

- Press a string (preferably, the third or fourth) simultaneously on frets 1 and 15. Check if the 0.010” string, working as a gauge, fits between the top of the seventh fret and the bottom of the chosen string. If it fits snugly, then stop here: you won’t need any adjustments.
- Remove the magnetic truss rod access cover: insert the small Hex key into its hole until you find some resistance, then pull.
- If the *gauge* (the 0.010” string) fits loose (so there is still some clearance), turn the adjustment nut with the large Hex key, clockwise as seen from the peghead end, an eighth of a turn or less (see drawing).

- If the *gauge* doesn't fit, turn the adjustment nut with the large Hex key, counter-clockwise as seen from the peghead end, an eighth of a turn or less (see drawing).
- Wait until the following day, then adjust the height of the bridge (Page 6) and repeat the process.
- Put in place the magnetic truss rod access cover again.

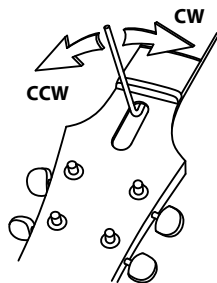

*Method B.- This is the way to adjust your guitar if your style involves all the fretboard.*

- Press a string (preferably, the third or fourth) simultaneously on frets 1 and 15. Press it lightly on the seventh fret and check if there is a gap between the fret and the string. If there is one, but it is extremely small, close to nothing, then stop here: you won't need any adjustments.
- Remove the magnetic truss rod access cover: insert the small Hex key into its hole until you find some resistance, then pull.
- If there is a noticeable gap between the fret and the string at fret #7, then turn the adjustment nut with the large Hex key, clockwise as seen from the peghead end, an eighth of a turn or less (see drawing).
- If the string is making contact with the seventh fret, turn the adjustment nut with the large Hex key, counter-clockwise as seen from the peghead end, an eighth of a turn or less (see drawing).
- Wait until the following day, then adjust the height of the bridge (Page 6) and repeat the process.
- Put in place the magnetic truss rod access cover again.



## Adjusting the Pickup-String Clearance

*You should do this...*

When you notice that the amplified sound of a string or group of strings is louder or weaker than the others, or when the output of the pickup is too high or too low. This adjustment is only for the magnetic pickup.

*Necessary tools:* You will need the small Hex key supplied with the guitar.

*Method:* The magnetic pickup in Siracusa 15R/16R guitars is set at a fixed height, so all the adjustments will be only on the individual polepieces, two per string. Turn them clockwise to reduce the output of a string, and counterclockwise to increase it.

*Note:*

The pickup in your guitar has two rows of polepieces. I favor this design because it makes possible to use bronze wound strings instead of the usual steel or nickel wound strings that are used for electric guitars. Let me explain this.

Bronze wound strings have a fantastic acoustic tone, but their volume is quite low when used with magnetic pickups. The plain strings in the set (usually the first and second) will have a much higher volume, resulting in a very strong imbalance. The logical way to correct this problem is to raise the polepieces of the wound strings and lower the polepieces of the plain strings, trying to equalize their output. However, in my experience, achieving an acceptable balance is impossible for pickups that feature adjustable polepieces just for one of their coils, no matter how extreme the adjustment (even removing the polepieces for the plain strings). However, it can be done if both coils have them, which is the way my pickups are made.



### **Checking/Replacing the Battery**

The battery will typically last hundreds of hours. It can be checked by inserting the small Hex key (supplied) into the hole in the battery cover (A in figure). Push gently and notice the color of the LED next to it: if green, the battery is fine. Otherwise (red or off), replace it, removing the four screws on the battery cover.

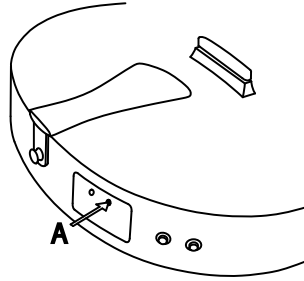

## USE

### Electric Controls

All the controls are located at the pickguard:

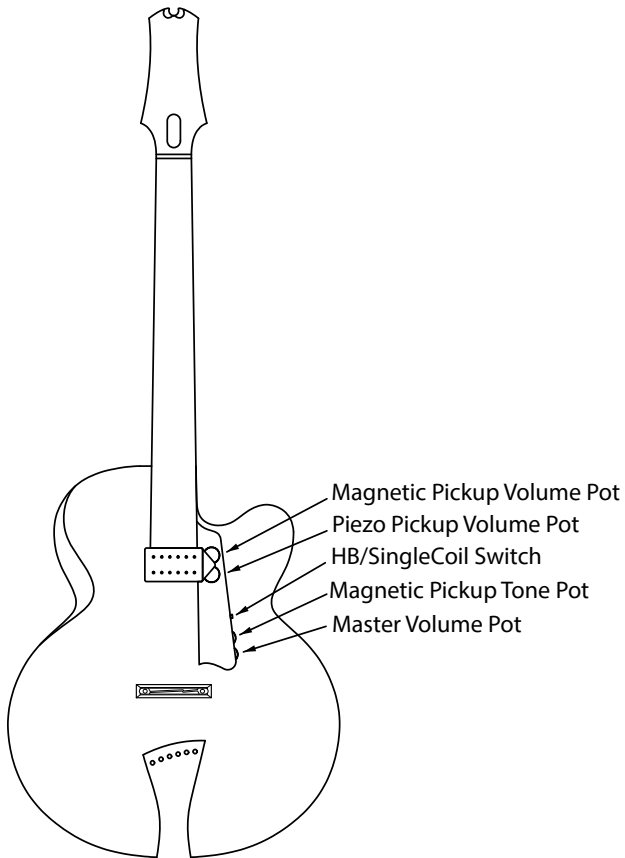



The independent volume controls for the two pickups, magnetic and piezo, are located close to the pickup, still above the pickguard. The master volume, which allows you to set the volume of both pickups at the same time, is located below the pickguard, just as the tone control for the magnetic pickup. These two mimic somehow the ones that you find in many single-pickup archtops, with some subtleties:

- The output of the guitar, controlled by the master volume, will have a fixed blend of piezo and magnetic, adjusted by means of the two independent volume controls. However, please notice that **the guitar always keeps the piezo and magnetic outputs separate.**
- The tone control will affect just the magnetic pickup. I put it there because all players expect to have it. However, the piezo does not have a tone control. More on this below.
- Most archtops with controls below the pickguard place the tone pot closer to the end of the pickguard. Here it is just the opposite; I think that the pot in that position is easier to find by touch, so it's the volume that goes there.

There is an additional control below the pickguard, a small switch that changes the magnetic pickup coil configuration from humbucker to single coil (*HB/SingleCoil Switch* in the drawing above). When in humbucker mode (towards the tailpiece), you'll have a fuller tone, more powerful and almost free of hum. In the single coil position (towards the peghead), the tone will be more clear and bright, less powerful and more prone to being affected by electromagnetic interference.

### **Deciding on the Amplifier**

The recommended way to connect this guitar is to use either a single amplifier with two independent channels or two separate amplifiers. If you like the first option better, there are some great amps from AER or Henriksen, for example. Separate amps can have the obvious advantage of their physical separation.



The logo consists of the word "Jaco" written in a stylized, cursive script. The letters are black and have a slightly irregular, hand-drawn appearance. The 'J' is particularly prominent, with a long, sweeping tail that loops back under the 'a'. The 'o' is a simple circle, and the 'c' is a simple curve. The 'o' and 'c' are connected to the 'a'.

Piezos need some hard processing to sound natural. Keep in mind that the preamp in this guitar is in reality a simple buffer, designed just for overcoming the problems that a passive piezo circuit would have with cables and potentiometers. If you want to get the best of it, you'll have to use a good piezo preamp or a good amp designed for piezo pickups.

## Connecting your Guitar

Before explaining this subject, you'll need some information about plugs and cables, summarized in the following table:

<p><b><u>PLUGS</u></b></p> <p>There are many different types, but conventional electric guitars use 1/4" TS Plugs. The TS indicates that they are designed to be used with a Shielded (hence the S) cable with a single conductor inside, available at the Tip (hence the T). There are also TRS plugs, meaning that they have another conductor inside the shield, connected to a Ring piece (R) right below the tip, and so they can transmit two separate signals.</p>	<p>The diagram shows two 1/4-inch audio plugs. The left one is a TRS (Tip, Ring, Shield) plug, with labels for its three conductive parts: Tip, Ring, and Shield. The right one is a TS (Tip, Shield) plug, with labels for its two parts: Tip and Shield.</p>
<p><b><u>CABLES</u></b></p>	
<ul style="list-style-type: none"><li>● A cable with 1/4" TS plugs at both ends is known as <b>Guitar Cable</b>.</li><li>● A cable with a 1/4" TRS plug at one end can be several things, depending on what's at the other end. Among all the possibilities:<ul style="list-style-type: none"><li>➢ If there is another 1/4" TRS plug, this is usually known as <b>Stereo Cable</b>. It carries two signals from the guitar to some other equipment that will take care of both.</li><li>➢ If there are two plugs, no matter their type, this is usually called <b>Y Cable</b>. There is some confusion here, because this Y shape, by itself, says little about its function, so that name is a generic. If there are TRS plugs at the other two ends of the Y, then this cable will simply fork a stereo signal to two stereo destinations. These cables serve no purpose for this guitar. The type with a 1/4" TRS plug at one end that forks into two 1/4" TS plugs at the other two ends of the Y is the one that is useful for us, and is usually called <b>Insert Cable</b>. A cable like this will allow you to route the two signals in the TRS plug (at its Tip and Ring) to two different devices or two separate inputs on the same device (at the Tip of each TS plug). There is a convention for telling apart the TS plugs in these cables: the one that is connected to the Ring of the TRS is Red. The other is usually black or white.</li></ul></li></ul>	
<p><b>Guitar Cables</b> and <b>Insert Cables</b> are the ones to use for connecting this guitar. Stereo Cables can be used in some situations where you have a stereo equipment managing both signals, but this is unusual.</p>	

The Siracusa 15R/16R has two jacks at its side, shown here:

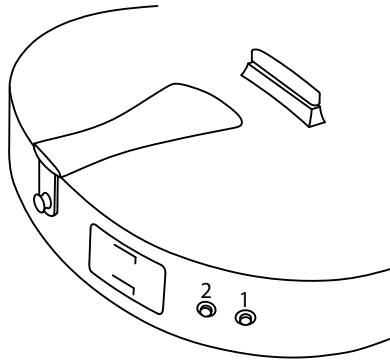

#1 is a Mono jack and #2 is a Stereo jack, both for 1/4" plugs. The most useful ways to connect this guitar are:

*a. Guitar Cable in #1, nothing in #2*

This is just like any conventional electric guitar with a magnetic pickup. You'll have two volume controls available (the one close to the pickup plus the master volume below the pickguard), plus the tone control and the HB/SingleCoil switch, these two below the pickguard.

This has the advantage that you don't need the battery to make it work. It won't use it either, so you may leave the cable connected permanently.

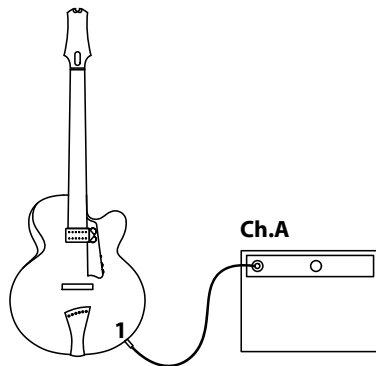



*b. Guitar Cable in #1, Guitar Cable in #2*

You can route the signals to two separate amps/amp channels for your piezo and magnetic pickups: #1 is the magnetic, #2 is the piezo. All the controls shown on Page 13 are operational.

This has the advantage that it uses Guitar Cables, easily available everywhere, so it may be really useful if you forgot to bring your special Insert Cable to the gig. Also if your amps are separated by more than what the Insert Cable permits.

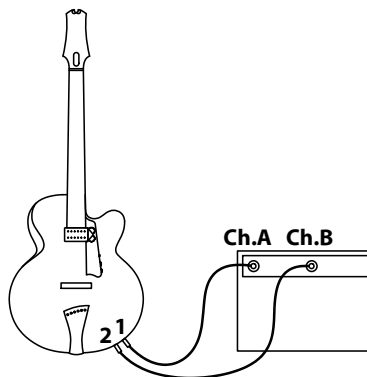

You must remove the cable from #2 when you are done playing; otherwise the battery will deplete.

*c. Nothing in #1, Insert Cable in #2*

You can route the signals to two separate amps/amp channels for your piezo and magnetic pickups. The black (or white) TS plug at one end of the Y corresponds to the piezo, the red TS plug at the other end corresponds to the magnetic. All the controls shown on Page 13 are operational.

Having a single cable at the guitar is an advantage. However, many times the distance between the two TS plugs is not enough for what you need; think for example

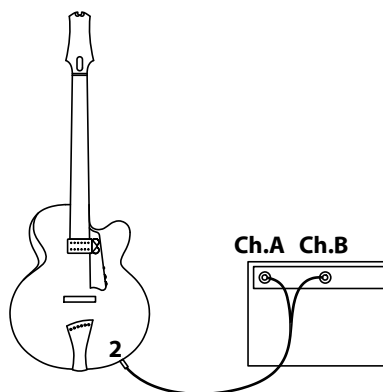



of two amplifiers located far from each other. **Your guitar comes with a Hosa STP-204 cable**, that you can use even if the amps are separated by meters. If you forgot to bring it to the gig, then use two cables, as in (b).

You must remove the cable when you are done playing; otherwise the battery will deplete.

There is a fourth possibility that is not exactly useful, but it is good to mention it in order to highlight a small detail in the operation of this guitar:

*d. Guitar Cable in #1, Insert Cable in #2*

You can route the signals to two separate amps for your piezo and your magnetic pickups, so it is equivalent to case (b), except it is more expensive and less elegant. That's not good, and shouldn't be in this list of useful combinations. But perhaps you are trying this because you want to connect a third amplifier. This won't work because, *the moment you connect a plug in jack #1, the signal from the magnetic pickup will only be available there.*

This is done to preserve the output of the magnetic pickup in case (b), which is really useful for the player but has the problem that the ring of jack #2 would get a direct path to ground due to the TS plug there.

You must remove the cable from #2 when you are done playing; otherwise the battery will deplete.

*Juén*

## Specifications

### Variable Materials:

- Wood: Usually maple/walnut/... and spruce for the soundbox; maple for the neck. The fretboard, peghead face, bridge and tailpiece are usually made of ebony. The pickguard skin is made of ebony most times (its core is always carbon), and the pickup is usually made of ziricote or ebony.
- The bindings are usually made of maple, walnut, ovangkol or sapelle, and the purfling is usually fiber.
- Most metal parts are gold plated.
- Some guitars substitute the mother-of-pearl inlay material for wood.
- The finish is either nitrocellulose or epoxy+Tru-oil.
- Case: Hiscox or custom made by Artur Benedykt.

### Fixed Materials:

- Carbon: The truss rod access cover and tuning machines cover are both carbon with a glued lamination of wood, usually ebony. The peghead has two internal carbon reinforcements where the tuners are attached. There is also a carbon base located inside the bridge saddle, where the piezos rest. The bridge feet are hollow, made of carbon fiber and wood, usually ebony, and joined by two carbon fiber rods. The pickguard has a carbon core hidden below its wooden skin. There are other internal pieces where carbon is used.
- The frets are Jescar FW47104SS (stainless steel).
- The kerfing is usually made of mahogany. It is installed using a proprietary method that makes the sides very strong without adding extra mass.
- The nut and the small pieces at the bridge saddle that cover the piezos, over which the strings press, are made of cow bone.
- The tuning machines are Schertlers, modified so that their mechanisms are hidden inside the peghead, usually with ebony knobs.
- The tailpiece bracket is made of aluminum with a wooden cover, usually ebony.
- The pickguard-neck bracket is made of brass.
- Piezos/Preamp: Custom individual mini piezo crystals with custom charge amplifier and battery check circuit.
- Magnetic pickup: Jaén *Crooked Mount* type, 50 mm polepiece spread.
- Pots: long rotational life (100.000 cycles), conductive polymer.

### Measurements:

- Neck: For non-custom instruments, the scale is 25.5" (648 mm), while the nut width is 1 11/16" (43 mm).
- Soundbox depth: usually around 65-70 mm.
- Siracusa 15R: 15 inches at lower bout.
- Siracusa 16R: 16 inches at lower bout

Guitarras Jaén - Fernando A. Jaén  
Ctra. De Pozorrubio, 92  
16410 Horcajo de Santiago (Cuenca)  
SPAIN

[www.guitarrasjaen.com](http://www.guitarrasjaen.com)  
[info@guitarrasjaen.com](mailto:info@guitarrasjaen.com)

Tel: +34 620791064