

*Juén*

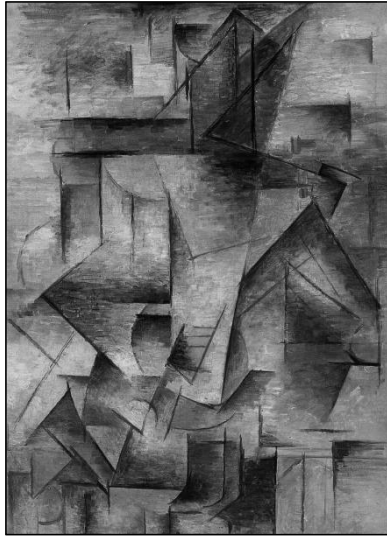

SIRACUSA 15E+/16E+  
— MANUAL —

MANSE+V10 - November 2023





## CONTENTS

<b>CARE</b>	<b>3</b> 
<b>MAINTENANCE</b>	<b>5</b>
<b>Tools</b>	<b>5</b>
<b>Changing Strings</b>	<b>5</b>
<b>Adjusting the Bridge Height</b>	<b>6</b>
<b>Adjusting the Compensation</b>	<b>7</b>
<b>Adjusting the Truss Rod Tension</b>	<b>9</b>
<b>Adjusting the Pickup-String Clearance</b>	<b>11</b>
<b>USE</b>	<b>13</b>
<b>Electric Controls</b>	<b>13</b>
<b>Box: Enhanced Single Coil Pickup</b>	<b>15</b>
<b>Box: Mid Pickup</b>	<b>15</b>
<b>Specifications</b>	<b>17</b>

*Juén*



Congratulations on your purchase of this Siracusa 15E+ or Siracusa 16E+ guitar!

Your satisfaction is my number one priority. **Thank You** for choosing my product, and please consider my guitars for future purchases.

## CARE



Siracusa guitars are nothing like conventional archtops with plates that triple the thickness, virtually indestructible. So, please, **read and observe what follows.**

-  **Do not allow the guitar to stay in places where humidity, temperature or light conditions are extreme.** These can affect very seriously the stability of wood and adhesives. **Relative Humidity must be kept around 50% at all times!**
- Try not to press excessively on the sides of your instrument. For example, trying to reach for something on the floor ahead of you while playing seated.
-  Oil finishes are soft, so they don't form a tough coat on top of the wood. This is really very different from the conventional guitar finishes that you already know. **If your guitar has an oil finish, treat it very carefully, especially the very soft top. Also, see page 8 for a special situation where the top can suffer damage.**
- Protect your instrument from accidents:
 

Try to keep it in its case, always with the drawbolts closed, when you are not using it. Do not trust too much in the stability of guitar stands.

Try not to wear buckles, key holders or zippers that may cause damage to the instrument while playing.



- Clean your instrument with well proven products designed specifically for this job. Avoid abrasive cleaners or those containing silicone or solvents such as alcohol or acetone.
- Do not try to lubricate the machine heads.
- Try to clean the strings after use with a dry clean cloth.
- Avoid the contact with alcoholic beverages. If it happens sometime, absorb them with a dry cloth without rubbing.
- Connect your instrument only to reliable equipment that have a ground connection. The power line must have a ground-fault interrupter. If you do not follow these recommendations, you can cause damage to the instrument as well as to yourself.
- If you are going to modify your instrument, contact me first.
- If you are a repairman working on this guitar, please contact me if you have any doubts on how to perform the repairs. I can also supply the necessary parts.
- Even if you are careful with your instrument, some wear will take place in normal use:
  - Frets must be redressed or changed after some time.
  - The finish and the wood below it can suffer color changes, usually to a more yellow/orange hue. The high gloss will not last a lifetime.
  - The gold or chrome plated pieces may lose their plating.

## MAINTENANCE

### Tools

Your guitar comes with a tool pouch, enough for the most common operations described below. It contains a small (2 mm) and a large (4 mm) Hex keys.

### Changing Strings

*You should do this...*

Whenever the strings don't sound bright, are worn or dirty or have tuning problems in certain areas of the fretboard.

*Necessary tools and materials:* Pliers and strings.

*Method:*

- Loosen one string. To untie it from the machines and the tailpiece, **cut it with the pliers**. This is the best way to avoid damaging the string anchors at the tailpiece, your fingers or the finish.
- Place the new string in the tailpiece.
- Insert the string into the hole in the post and pull until it is around 50 mm high above the fretboard.
- Bend the end slightly, just at the exit from the tuner post.
- Turn the tuner until the string feels tight, then tune it.
- Cut the remaining, leaving about 1 cm out of the post.
- Repeat for each string.



## Adjusting the Bridge Height

*You should do this...*

Whenever there are buzzes in wide areas of the fretboard. The height may be lowered if the action is too high and there are no buzzes.

*Necessary tools:* Small Hex key, supplied with the guitar.

*Method:*

Depending on the problem affecting more the bass strings than the treble strings, you will have to turn the corresponding adjustment screw to each side of the bridge saddle. Clockwise to lower it, and counterclockwise to raise it. The adjustment will be finished when the strings are high enough so that, in your playing style, there are no buzzes.

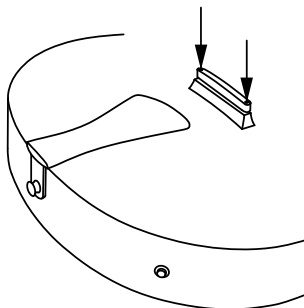

*Notes:*

- I usually set the action very low before delivering my instruments. You can always raise it if you like it better.
- If you use **thin** plain strings, it is possible to have buzzes because they don't have enough tension for straightening out the small irregularities in the steel caused by playing. Use new strings before performing any adjustment.
- After this adjustment, you should also check the truss rod tension and compensation adjustments, as explained later.



## Adjusting the Compensation

This procedure must be performed so that all the notes and their octaves sound reasonably in unison, independent from their position on the fretboard. A guitar that is not well compensated can be especially unpleasant when playing chords that mix notes fingered in high frets with open strings.

*You should do this...*

- When your new strings are a different gauge, or you plan to use an alternate tuning permanently.
- When the bridge has been moved, usually as a consequence of removing all the strings (which I don't recommend).
- When the height of the bridge has been modified substantially.

*However...*

- Don't do this every time that you change the strings, it's not necessary.
- Don't do this if you find that your worn strings don't intonate well. Instead, change them and check if the new ones are OK.

*Necessary tools:* Electronic tuner or a good ear.

*Method:*

- Start with new strings, *already tuned in the guitar for at least a few hours.*
- Check if the natural harmonic for the second string in fret 12 is the same as the fingered note in that same fret. If the tuner (or your ear) finds that the fingered note is higher than the harmonic, the

bridge will have to be moved closer to the tailpiece. Otherwise, move it further away from the tailpiece (see drawing).

- Check the same for the fifth string, but this time try to move only the bass side of the bridge, as you should not modify its position for the string that you adjusted first.

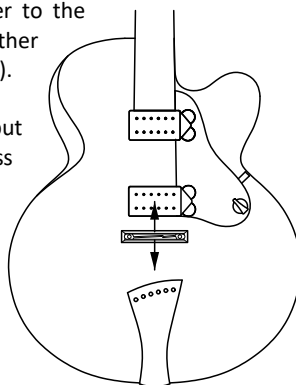

Notes:

-  Some bridges may be hard to move. Don't force anything, you can damage the top if you press hard on it. It is better to loosen the strings but, **if the finish is oil, then loosen the strings completely!**
- Worn strings, deformed from playing or dirty can be impossible to play in tune—never try to adjust the compensation for old strings, it's wasted time.
- Some wound strings have defects in the uniformity of their windings that make them useless. Plain strings have their problems too: some show a kind of coiling right out of the package that doesn't correspond to the curvature that they assumed while in the package—don't use these, especially if they are in a low tension set.
- The fixed bridges found in archtop guitars don't allow a perfect adjustment for every string, but the discrepancy is usually quite small.
- The saddle in your guitar has been adjusted for string sets that have a wound third string. If you use a plain third, you may need a different saddle. Inquire.

## Adjusting the Truss Rod Tension

*You should do this...*

When there are buzzes but the action is high. This has three main probable causes:

- Change of the tension exerted on the neck, usually following the change of the string gauge or alternate tunings.
- Wood adaptation to the strings/truss rod tension and compression forces. This is especially important during the first year of life of the instrument.
- Changes in relative humidity.

*Necessary tools:* There are two different methods, depending on your playing style. To perform the “A” method you will need a thin guitar string (0.010”) and, perhaps, some assistance. For the “B” method, you won’t need the string. If, after the check, you must make the adjustment, you will need both the small and the large Hex keys supplied with the guitar.

*Method A.- This is the way to adjust your guitar if your style is more limited to the first frets, including lots of open strings.*

- Press a string (preferably, the third or fourth) simultaneously on frets 1 and 15. Check if the 0.010” string, working as a gauge, fits between the top of the seventh fret and the bottom of the chosen string. If it fits snugly, then stop here: you won’t need any adjustments.
- Remove the magnetic truss rod access cover: insert the small Hex key into its hole until you find some resistance, then pull.
- If the *gauge* (the 0.010” string) fits loose (so there is still some clearance), turn the adjustment nut with the large Hex key, clockwise as seen from the peghead end, an eighth of a turn or less (see drawing).

- If the *gauge* doesn't fit, turn the adjustment nut with the large Hex key, counter-clockwise as seen from the peghead end, an eighth of a turn or less (see drawing).
- Wait until the following day, then adjust the height of the bridge (Page 6) and repeat the process.
- Put in place the magnetic truss rod access cover again.

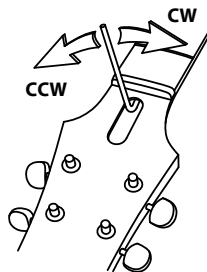

*Method B.- This is the way to adjust your guitar if your style involves all the fretboard.*

- Press a string (preferably, the third or fourth) simultaneously on frets 1 and 15. Press it lightly on the seventh fret and check if there is a gap between the fret and the string. If there is one, but it is extremely small, close to nothing, then stop here: you won't need any adjustments.
- Remove the magnetic truss rod access cover: insert the small Hex key into its hole until you find some resistance, then pull.
- If there is a noticeable gap between the fret and the string at fret #7, then turn the adjustment nut with the large Hex key, clockwise as seen from the peghead end, an eighth of a turn or less (see drawing).
- If the string is making contact with the seventh fret, turn the adjustment nut with the large Hex key, counter-clockwise as seen from the peghead end, an eighth of a turn or less (see drawing).
- Wait until the following day, then adjust the height of the bridge (Page 6) and repeat the process.
- Put in place the magnetic truss rod access cover again.

## Adjusting the Pickup-String Clearance

*You should do this...*

When you notice that the amplified sound of a string or group of strings is louder or weaker than the others, or when the output of a pickup is too high or too low.

*Necessary tools:* You will need the small Hex key supplied with the guitar.

*Method:*

The neck pickup is set at a fixed height, so all the adjustments will be only on the individual polepieces, two per string. Turn them clockwise to reduce the output of a string, and counterclockwise to increase it.

The height of the bridge pickup can indeed be modified. This is useful if, for example, you are trying to balance it with the neck pickup so that both have a similar maximum output. To do it, loosen the screws S (see drawing) enough so that you can raise or lower the pickguard bracket, and then tighten them again. After this coarse adjustment you can proceed to make fine adjustments to the polepieces, the same as you did for the neck pickup.

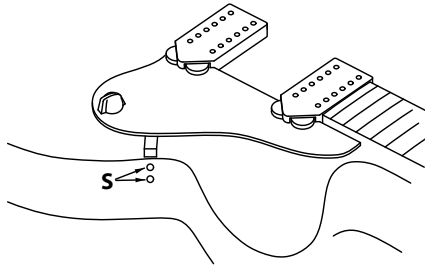

*Note:*

The pickups in your guitar have two rows of polepieces. I favor this design because it makes possible to use bronze wound strings instead of the usual steel or nickel wound strings that are used for electric guitars. Let me explain this.



Bronze wound strings have a fantastic acoustic tone, but their volume is quite low when used with magnetic pickups. The plain strings in the set (usually the first and second) will have a much higher volume, resulting in a very strong imbalance. The logical way to correct this problem is to raise the polepieces of the wound strings and lower the polepieces of the plain strings, trying to equalize their output. However, in my experience, achieving an acceptable balance is impossible for pickups that feature adjustable polepieces just for one of their coils, no matter how extreme the adjustment (even removing the polepieces for the plain strings). However, it can be done if both coils have them, which is the way my pickups are made.

## USE

### Electric Controls

All the controls are located at the pickguard:

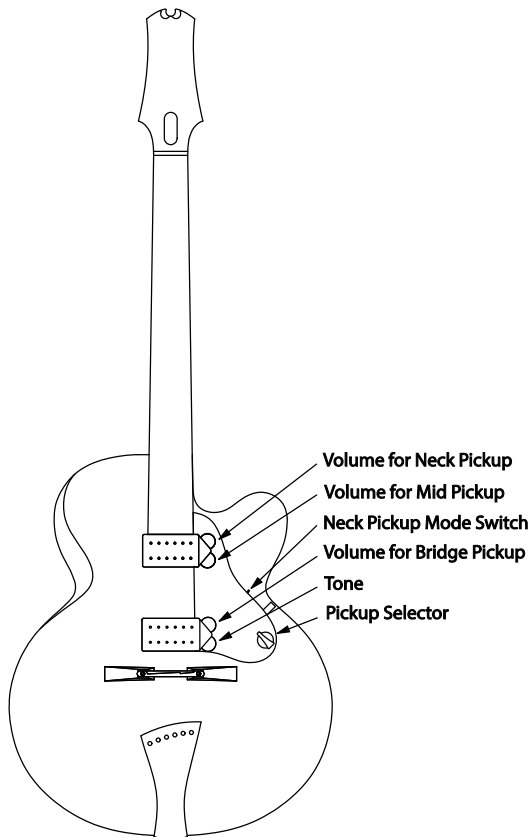

**Pickup Selector in the Neck Position.-** There are two cases, depending on the *Neck Pickup Mode Switch*. If it is in the HB position (toggle towards the peghead, A in the drawing below) then the selected pickup will be a series humbucker made up by the two coils closer to the neck. In the SC position (toggle towards the tailpiece, B in the drawing below) the pickup will be a special type of single coil that I call *Enhanced Single Coil* (see the first box in page 15). The volume and tone knobs are the same in both cases, and are shaded in the diagram.

**Pickup Selector in the Mid Position.-** The selected pickup will be a series humbucker made up by the most extreme coils, the one closer to the neck and the one closer to the bridge (C in the drawing below, see the second box in page 15). The volume and tone knobs for this position are shaded in the diagram; the position of the *Neck Pickup Mode Switch* is irrelevant.

**Pickup Selector in the Bridge Position.-** The selected pickup will be a series humbucker made up by the two coils closer to the bridge (D in the drawing below). The volume and tone knobs for this position are shaded in the diagram; the position of the *Neck Pickup Mode Switch* is irrelevant.

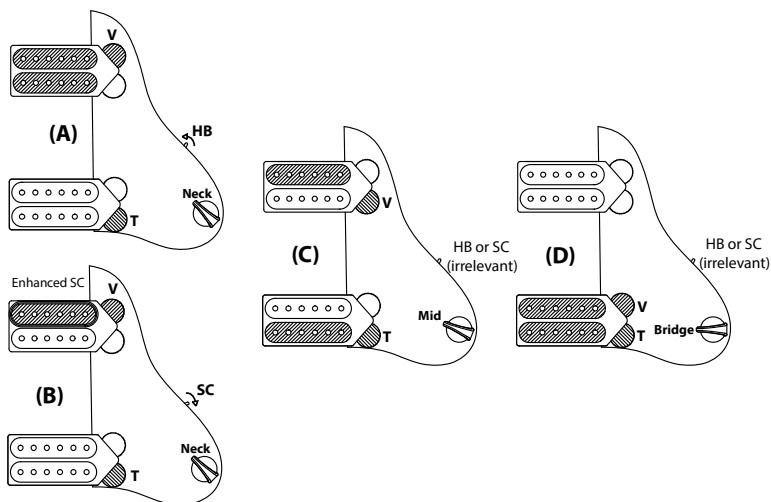



### Enhanced Single Coil Pickup

The *Neck Pickup Mode Switch* permits to select either a *Humbucker* or a *Single Coil* for the neck pickup. When in *Humbucker* mode (toggle towards the peghead, see diagram A on previous page), you'll have a full tone, almost free of hum. In the *Single Coil* position (toggle towards the tailpiece, B on that same diagram), the tone of the neck pickup will be more clear and bright, although more prone to being affected by electromagnetic interference.

Single coil pickups obtained by canceling one of the coils of a humbucker (as done here) are usually disregarded by most players, as they tend to be weaker than *real* single coils. Nonetheless, your Siracusa 15E+/16E+ guitar has a **very uncommon neck pickup and circuitry**: when in single coil mode, a third coil is added on top, giving you the tone and punch that you expect from a *real* single coil. I like to call this the *Enhanced Single Coil* mode.

### Mid Pickup

Most guitars with two humbuckers use the mid position of the pickup selector to connect the neck and bridge pickups in parallel. This is a simple wiring arrangement, but it causes interactions (usually unwanted) between volume and tone pots, that are also connected in parallel together with the pickups.

Instead, for the mid position of the switch, the Siracusa 15E+/16E+ does as follows:

- It makes up another pickup (the *Mid Pickup*) by taking a coil from the neck pickup and another from the bridge pickup, and connecting them *in series*. These coils are the one closer to the neck and the one closer to the bridge, so this new pickup *is also a series humbucker, the same as the other two*.
- *It has its own volume control, independent from the other two.*

*Juén*



## Specifications

### Variable Materials:

- Wood: Usually maple, walnut or sapele for the back and sides, and spruce for the top; maple for the neck. The fretboard, peghead face, bridge and tailpiece are usually made of ebony. The pickguard skin is made of zircote most times (its core is always carbon), and the pickups are usually made of zircote or ebony.
- The bindings are usually maple, walnut, ovankol or sapele, and the purfling is usually fiber.
- Most metal parts are gold plated.
- Some guitars substitute the mother-of-pearl inlay material for wood.
- The finish is either nitrocellulose or epoxy+Tru-oil.
- Case: Hiscox or custom made by Artur Benedykt.

### Fixed Materials:

- Carbon: The truss rod access cover and tuning machines cover are both carbon with a glued lamination of wood, usually ebony. The peghead has two internal carbon reinforcements where the tuners are attached. There is also a carbon skeleton inside the bridge saddle that stiffens it. The bridge feet are hollow, usually made of ebony, and joined by two carbon fiber rods. The pickguard has a carbon core hidden below its wooden skin. There are other internal pieces where carbon is used.
- The frets are Jescar FW47104SS, Stainless Steel.
- The kerfing is usually made of mahogany. It is installed using a proprietary method that makes the sides very strong without adding extra mass.
- The nut is made of cow bone.
- The tuning machines are Schertlers, modified so that their mechanisms are hidden inside the peghead, usually with ebony knobs.
- The tailpiece bracket is made of aluminum covered with a wooden veneer, usually ebony.
- The main pickguard bracket is made of blackened steel. The neck bracket is made of brass.
- Magnetic pickups: Neck PU with 50 mm and Bridge PU with 52 mm polepiece spread. The neck pickup can work in *enhanced single coil* mode.
- Potentiometers: long rotational life (100.000 cycles), conductive polymer.

### Measurements:

- Neck: For non-custom instruments, the scale is 25.5" (648 mm), while the nut width is 1 11/16" (43 mm).
- Soundbox depth: usually around 65-70 mm.
- Siracusa 15E+: 15 inches at lower bout.
- Siracusa 16E+: 16 inches at lower bout

Guitarras Jaén - Fernando A. Jaén  
Ctra. De Pozorrubio, 92  
16410 Horcajo de Santiago (Cuenca)  
SPAIN

[www.guitarrasjaen.com](http://www.guitarrasjaen.com)  
[info@guitarrasjaen.com](mailto:info@guitarrasjaen.com)

Tel: +34 620791064